



Applications:

- Myers™ hubs are used in the termination of electrical circuits through wall of the enclosure
- Designed for use indoors or outdoors with rigid conduit and IMC
- Ideal for pharmaceutical, chemical and food processing, pulp/paper, nuclear, solar and commercial construction applications
- Resistant to a variety of chemicals, including acetic, citric and salt water
- Special design of o-ring gasket provides excellent environmental ratings and chemical resistance
- Hub is provided with a stainless steel ground nut

Features:

- Wide range of styles, trade sizes and materials to meet customer requirements and preferences
- Multiple certifications provide users peace of mind
- Easy installation and smooth pulling service for labor savings
- Tapered female threads for rigid/IMC conduit, NPSM male threads

Certifications and compliances:

- NEC/CEC:
 - Class I, Division 2
 - Class II, Divisions 1 & 2
 - Class III, Divisions 1 & 2
 - Class I, Zone 1, AEx e II
 - Class I, Zone 1, Ex e II
- cULus Listed
 - UL Standard 514B
 - CSA Standard C22.2 No. 18
- NEMA Type 2, 3, 3R, 4, 4X, 12 (std. hub and ground hub)
- IEC:
 - STGK:
 - ATEX Certified ITS12ATEX47591X Ex  II 2G Ex e IIC Gb to EN 60079-0:2009, EN 60079-7:2007, and EN 60079-14 Standards Ta -15°C to 120°C
 - IECEX Certified IECEX ETL 12.0009X Ex e IIC Gb to IEC 60079-0:2007-10, Edition 5, IEC 60079-7:2006-07, Edition 4 and IEC 60079-14 Standards Ta -15°C to 120°C
 - IP66
 - SSTGK M2:
 - ATEX Certified DEMKO 18 ATEX 2002X,  II 2G Ex eb IIC Gb to EN IEC 60079-0:2018 and EN IEC 60079-7:2015 +A1:2018 standards Ta -55°C to 180°C
 - IECEX Certified IECEX UL 18.0007X, Ex eb IIC Gb to IEC 60079-0:2017 and IEC 60079-7:2017 standards Ta -55°C to 180°C
 - IP66



Standard materials:

- Nut: Zinc (Zamek-2, Zamek-3), aluminum (Al 360), stainless (316)
- Body: Zinc (Zamek-2, Zamek-3), aluminum (Al 360), stainless (316)
- Insuliner: Lexan, PEEK GF15 (SSTGK M2 only)
- O-Ring: Viton; silicone (SSTGK M2 only)
- Ground Screw: Steel/stainless steel

Standard finishes:

- Aluminum – natural
- Zinc – natural
- Stainless – natural

Options:

- | Description | Suffix |
|--|--------|
| • Nickel-chrome plate finish (available on zinc hubs only) | CP |

Myers hubs design features

1 Grounding screw

- For added safety

2 Vibration-proof

- Strong, oversize nut with radial serrations helps assure flush installation and positive grounding

2 Posi-lok insulated throat

- Cannot come out, standard in sizes from 1/2" through 4"

4 Precision machine cut threads

- Positive fit and simple installation

5 No welding

- Unique serrations on both nut and hub bite into metal assuring a positive electrical ground. (UL approved for use with service entrance conduit)

6 Captive o-ring gasket

- Impervious to corrosive moisture and petroleum products. Gasket helps assure positive water and dust-tight installations



Available in trade sizes 3/8" through 6"

Hub Basic Scru-Tite™

Hubs are ideal for general use with rigid conduit. Provides positive seal and electrical ground.

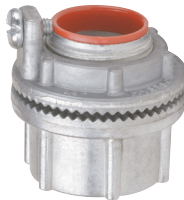

Available in trade sizes 1/2" through 6"

Ground hub

Combines all of the features of the Hub Basic Scru-Tite plus the additional feature of the grounding screw on the locknut.



Stainless steel now rated for -55°C to 180°C

Available in trade sizes 1/2" through 4"

ATEX rated hub

Hub is listed for use in hazardous (classified) locations to IECEx-ATEX certifications. Ideal for global requirements and OEM's shipping material worldwide.

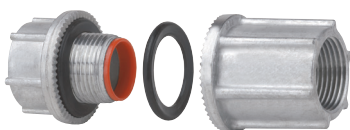

Through-bulkhead fitting

Hubs are the perfect method for installing hubs on cast boxes or through thicker walls.



Metric to NPT adapter

Used to convert a threaded metric entry to a NPT entry.



Drain plugs

Designed to install in the bottom of an enclosure to drain any accumulated condensation. Available in aluminum or stainless steel construction.



Cap-off

Designed to install in enclosure to provide environmental cap for unused entries or knockouts.

Myers hubs

HUB BASIC SCRU-TITE – NEMA 2, 3, 3R, 4, 4X, 12

Zinc

UL File No. E-27258



Cat. #	Size	Unit qty.	Wt. lbs. per 100
ST 03 ^⓪	3/8"	25	11
ST 1 ^⓪	1/2"	25	19
ST 2 ^⓪	3/4"	25	27
ST 3 ^⓪	1"	25	40
ST 4 ^⓪	1 1/4"	10	51
ST 5 ^⓪	1 1/2"	10	68
ST 6 ^⓪	2"	10	92
ST 7 ^⓪	2 1/2"	5	210
ST 8 ^⓪	3"	2	245
ST 9 ^⓪	3 1/2"	2	278
ST 10 ^⓪	4"	2	318
ST 11 ^⓪	5"	1	478
ST 12 ^⓪	6"	1	685

^⓪Optional nickel-chrome plate finish. Add suffix -CP.

[Ⓟ]Not supplied with insulator.

Conduit hubs

HUB BASIC SCRU-TITE – NEMA 2, 3, 3R, 4, 4X, 12

Aluminum

UL File No. E-27258



Cat. #	Size	Unit qty.	Wt. lbs. per 100
STA 1	1/2"	25	8
STA 2	3/4"	25	11
STA 3	1"	25	17
STA 4	1 1/4"	10	30
STA 5	1 1/2"	10	30
STA 6	2"	10	38
STA 7	2 1/2"	5	80
STA 8	3"	2	100
STA 9	3 1/2"	2	138
STA 10	4"	2	150
STA 11 [Ⓟ]	5"	1	300
STA 12 [Ⓟ]	6"	1	300

[Ⓟ]Not supplied with insulator.

GROUND HUB – NEMA 2, 3, 3R, 4, 4X, 12

316 Stainless steel

UL File No. E-59509

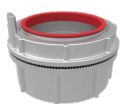

Cat. #	Size	Unit qty.	Wt. lbs. per 100
SSTG 1	1/2"	10	29
SSTG 2	3/4"	10	41
SSTG 3	1"	10	57
SSTG 4	1 1/4"	5	73
SSTG 5	1 1/2"	5	99
SSTG 6	2"	5	134
SST 7 [Ⓟ]	2 1/2"	2	183
SST 8 [Ⓟ]	3"	2	278
SST 9 [Ⓟ]	3 1/2"	2	328
SST 10 [Ⓟ]	4"	2	395

[Ⓟ]Not UL Listed as means of grounding and bonding. Does not include tapped ground tab or ground screw.

GROUND HUB – NEMA 2, 3, 3R, 4, 4X, 12

Zinc

UL File No. E-59509



Cat. #	Size	Unit qty.	Wt. lbs. per 100	Max. Copper Grd. Wire Size	
				CSA ^⓪	UL ^⓪
STG 1	1/2"	25	20	#8	#8
STG 2	3/4"	25	28	#8	#8
STG 3	1"	25	42	#8	#8
STG 4	1 1/4"	10	55	#8	#8
STG 5	1 1/2"	10	70	#6	#8
STG 6	2"	10	95	#4	#8
STG 7	2 1/2"	5	190	#2	#6
STG 8	3"	2	243	1/0	#6
STG 9	3 1/2"	2	300	2/0	#6
STG 10	4"	2	323	2/0	#4
STG 11 [Ⓟ]	5"	1	625	2/0	#2
STG 12 [Ⓟ]	6"	1	750	3/0	#1

[Ⓟ]Not supplied with insulator.

^⓪Use of wire terminal is required by CSA and recommended by UL for wire gauges over 10 AWG.

GROUND HUB – NEMA 2, 3, 3R, 4, 4X, 12

Aluminum

UL File No. E-59509



Cat. #	Size	Unit qty.	Wt. lbs. per 100	Max. Copper Grd. Wire Size	
				CSA ^⓪	UL ^⓪
STAG 1	1/2"	25	13	#8	#8
STAG 2	3/4"	25	14	#8	#8
STAG 3	1"	25	18	#8	#8
STAG 4	1 1/4"	10	25	#8	#8
STAG 5	1 1/2"	10	33	#6	#8
STAG 6	2"	10	41	#4	#8
STAG 7	2 1/2"	5	90	#2	#6
STAG 8	3"	2	103	1/0	#6
STAG 9	3 1/2"	2	138	2/0	#6
STAG 10	4"	2	140	2/0	#4
STAG 11 [Ⓟ]	5"	1	325	3/0	#2
STAG 12 [Ⓟ]	6"	1	350	3/0	#1

[Ⓟ]Not supplied with insulator.

^⓪Use of wire terminal is required by CSA and recommended by UL for wire gauges over 10 AWG.

ATEX HAZARDOUS LOCATION HUB WITH INCREASED SAFETY GROUND TERMINAL

Zinc – NEMA 2, 3, 3R, 4, 4X; IP66

 II 2 G Ex e IIC Gb Ta (-15°C to 120°C)

IECEX – Ex e IIC Gb Ta (-15°C to 120°C)
Class I, Zone 1, AEx e II
Class I, Zone 1, Ex e II

UL File No. E-59509



Cat. #	Size	Unit qty.	Wt. lbs. per 100	Max. Copper Grd. Wire Size	
				CSA®	UL®
STGK 1	1/2"	10	20	#8	#8
STGK 2	3/4"	10	31	#8	#8
STGK 3	1"	10	44	#8	#8
STGK 4	1 1/4"	5	60	#8	#8
STGK 5	1 1/2"	5	73	#6	#8
STGK 6	2"	5	99	#4	#8
STGK 7	2 1/2"	2	145	#2	#6
STGK 8	3"	2	243	1/0	#6
STGK 9	3 1/2"	2	304	2/0	#6
STGK 10	4"	2	327	2/0	#4

Ⓢ Use of wire terminal is required by CSA and recommended by UL for wire gauges over 10 AWG.

ATEX HAZARDOUS LOCATION HUB WITH INCREASED SAFETY GROUND TERMINAL

316 Stainless steel – NEMA 2, 3, 3R, 4, 4X; IP66

 II 2 G Ex eb IIC Gb Ta (-55°C to 180°C)

IECEX – Ex eb IIC Gb Ta (-55°C to 180°C)
Class I, Zone 1, AEx e II
Class I, Zone 1, Ex e II

UL File No. E-187273



Cat. #	Size	Unit qty.	Wt. lbs. per 100	Max. Copper Grd. Wire Size	
				CSA®	UL®
SSTGK 1 M2	1/2"	10	33	#8	#8
SSTGK 2 M2	3/4"	10	44	#8	#8
SSTGK 3 M2	1"	10	60	#8	#8
SSTGK 4 M2	1 1/4"	5	76	#8	#8
SSTGK 5 M2	1 1/2"	5	103	#6	#8
SSTGK 6 M2	2"	5	137	#4	#8
SSTGK 7 M2Ⓢ	2 1/2"	2	185	#2	#6
SSTGK 8 M2Ⓢ	3"	2	281	1/0	#6
SSTGK 9 M2Ⓢ	3 1/2"	2	331	2/0	#6
SSTGK 10 M2Ⓢ	4"	2	399	2/0	#4

Ⓢ Use of wire terminal is required by CSA and recommended by UL for wire gauges over 10 AWG.

Ⓢ Not UL Listed as means of grounding and bonding.

THROUGH-BULKHEAD FITTING – ZINC

UL File No. E-27258



Cat. #	Size	Unit qty.	Wt. lbs. per 100
STTB 1	1/2"	5	30
STTB 2	3/4"	5	50
STTB 3	1"	5	70
STTB 4	1 1/4"	5	85
STTB 5	1 1/2"	5	110
STTB 6	2"	5	152
STTB 7	2 1/2"	4	280
STTB 8	3"	2	408
STTB 9	3 1/2"	2	468
STTB 10	4"	2	533

THROUGH-BULKHEAD FITTING – ALUMINUM

UL File No. E-27258



Cat. #	Size	Unit qty.	Wt. lbs. per 100
STTBA 1	1/2"	5	11
STTBA 2	3/4"	5	21
STTBA 3	1"	5	31
STTBA 4	1 1/4"	5	40
STTBA 5	1 1/2"	5	50
STTBA 6	2"	5	65
STTBA 7	2 1/2"	4	106
STTBA 8	3"	2	175

THROUGH-BULKHEAD FITTING – ZINC WITHOUT NIPPLES

Packaged as two pieces unassembled
UL File No. E-27258



Cat. #	Size	Unit qty.	Wt. lbs. per 100
STTTB 1	1/2"	5	35
STTTB 2	3/4"	5	58
STTTB 3	1"	5	85
STTTB 4	1 1/4"	5	105
STTTB 5	1 1/2"	5	135
STTTB 6	2"	5	169

THROUGH-BULKHEAD FITTING – ALUMINUM WITHOUT NIPPLES

Packaged as two pieces unassembled
UL File No. E-27258



Cat. #	Size	Unit qty.	Wt. lbs. per 100
STTTBA 1	1/2"	5	16
STTTBA 2	3/4"	5	25
STTTBA 3	1"	5	35
STTTBA 4	1 1/4"	5	40
STTTBA 5	1 1/2"	5	50
STTTBA 6	2"	5	75

Conduit hubs

Myers hubs

Conduit hubs

METRIC TO NPT ADAPTER – ZINC



Cat. #	Size	Unit qty.	Wt. lbs. per 100
STM 1	M20 - 1/2"	25	13
STM 2	M25 - 3/4"	25	19
STM 3	M32 - 1"	25	32
STM 4	M40 - 1 1/4"	10	40
STM 5	M50 - 1 1/2"	10	57
STM 6	M63 - 2"	10	70

Note: The Myers metric to NPT hub adapter is used to convert a threaded metric entry to an NPT entry. The female thread is NPT and the male thread is metric.

GROUND NUT – ZINC

UL File No. E-59509



Max. copper
grd. wire size

Cat. #	Size	Unit qty.	Wt. lbs. per 100	CSA [Ⓞ]	UL [Ⓞ]
STGN 1	1/2"	25	6	#8	#8
STGN 2	3/4"	25	10	#8	#8
STGN 3	1"	25	13	#8	#8
STGN 4	1 1/4"	10	15	#8	#8
STGN 5	1 1/2"	10	23	#6	#8
STGN 6	2"	10	28	#4	#8

[Ⓞ] Use of wire terminal is required by CSA and recommended by UL for wire gauges over 10 AWG.

GROUND NUT – ALUMINUM

UL File No. E-59509



Max. copper
grd. wire size

Cat. #	Size	Unit qty.	Wt. lbs. per 100	CSA [Ⓞ]	UL [Ⓞ]
STAGN 1	1/2"	25	3	#8	#8
STAGN 2	3/4"	25	4	#8	#8
STAGN 3	1"	25	6	#8	#8
STAGN 4	1 1/4"	10	8	#8	#8
STAGN 5	1 1/2"	10	11	#6	#8
STAGN 6	2"	10	14	#4	#8

[Ⓞ] Use of wire terminal is required by CSA and recommended by UL for wire gauges over 10 AWG.

CAP-OFF – ZINC

UL File No. E-23223

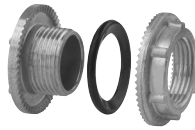

Cat. #	Size	Unit qty.	Wt. lbs. per 100
STC 1 [Ⓞ]	1/2"	25	13
STC 2 [Ⓞ]	3/4"	25	19
STC 3 [Ⓞ]	1"	25	28
STC 4 [Ⓞ] [Ⓞ]	1 1/4"	10	40
STC 5 [Ⓞ] [Ⓞ]	1 1/2"	10	50
STC 6 [Ⓞ] [Ⓞ]	2"	10	67

[Ⓞ] Optional nickel-chrome plate finish. Add suffix -CP.
[Ⓞ] Not UL Listed.

CAP-OFF – ALUMINUM

UL File No. E-23223



Cat. #	Size	Unit qty.	Wt. lbs. per 100
STAC 1	1/2"	25	5
STAC 2	3/4"	25	8
STAC 3	1"	25	12

NON-HAZARDOUS DRAIN PLUG – 316 STAINLESS STEEL

UL File No. E-23223

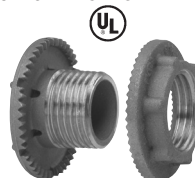

SSTS 1



SSTS 1CD

Cat. #	Size	Unit qty.	Wt. lbs. per 100
SSTS 1	1/2"	25	17
SSTS 1CD	1/2"	10	12

NON-HAZARDOUS DRAIN PLUG – ALUMINUM

UL File No. E-23223

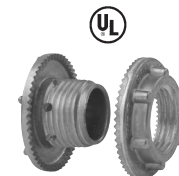

STAC 1ST



STAC 1CD

Cat. #	Size	Unit qty.	Wt. lbs. per 100
STAC 1ST	1/2"	25	6
STAC 1CD	1/2"	25	2

Note: SSTS 1 and STAC 1ST are for knockouts and are supplied with a locknut and straight threads. SSTS 1CD and STAC 1CD are for threaded openings and are supplied without locknut and NPT threads. Not gasketed to allow for water drainage.

Hub dimensions (in inches):

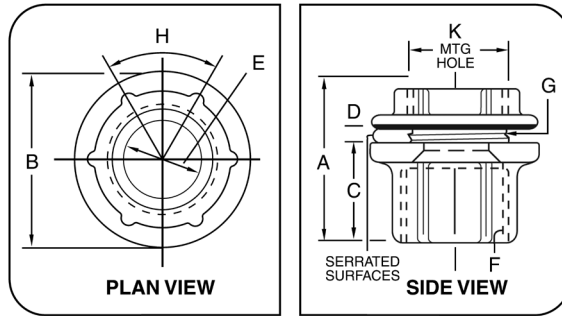

"D" dimension indicates maximum panel thickness which hub will accommodate.

Pipe size	A	B	C	D	E		F	G	H	K (mounting hole)	
					Min.	Max.				Min.	Max.
3/8	1 ³ / ₃₂	1 ¹ / ₈	2 ¹ / ₃₂	1 ¹ / ₈	0.468	0.493	3/8 NPT	3/8 NPSM	60°	43/64	11/16
1/2	1 ¹¹ / ₃₂	1 ⁷ / ₁₆	1 ³ / ₁₆	3/16	0.591	0.622	1/2 NPT	1/2 NPSM	60°	55/64	7/8
3/4	1 ¹⁵ / ₃₂	1 ²³ / ₃₂	2 ⁹ / ₃₂	3/16	0.783	0.824	3/4 NPT	3/4 NPSM	60°	1 ¹ / ₁₆	1 ¹ / ₈
1	1 ²¹ / ₃₂	2	1 ¹ / ₃₂	1/4	0.997	1.049	1 NPT	1 NPSM	60°	1 ²¹ / ₆₄	1 ³ / ₈
1 1/4	1 ¹¹ / ₁₆	2 ³ / ₈	1 ¹ / ₃₂	1/4	1.311	1.380	1 1/4 NPT	1 1/4 NPSM	60°	1 ⁴³ / ₆₄	1 ³ / ₄
1 1/2	1 ¹¹ / ₁₆	2 ³ / ₄	1 ¹ / ₃₂	1/4	1.529	1.610	1 1/2 NPT	1 1/2 NPSM	60°	1 ⁵⁹ / ₆₄	2
2	1 ³ / ₄	3 ¹ / ₄	1 ³ / ₃₂	1/4	1.964	2.067	2 NPT	2 NPSM	60°	2 ²⁵ / ₆₄	2 1/2
2 1/2	2 ¹ / ₃₂	3 ³ / ₄	1 ⁹ / ₃₂	1/4	2.346	2.469	2 1/2 NPT	2 1/2 NPSM	60°	2 ⁵⁷ / ₆₄	3
3	2 ⁵ / ₁₆	4 ³ / ₈	1 ³ / ₈	1/4	2.915	3.068	3 NPT	3 NPSM	45°	3 ³³ / ₆₄	3 ⁵ / ₈
3 1/2	2 ³ / ₈	5	1 ⁷ / ₁₆	1/4	3.371	3.548	3 1/2 NPT	3 1/2 NPSM	45°	4 ¹ / ₆₄	4 ¹ / ₈
4	2 ⁷ / ₁₆	5 1/2	1 1/2	1/4	3.825	4.026	4 NPT	4 NPSM	45°	4 ³³ / ₆₄	4 ⁵ / ₈
5	2 ¹⁵ / ₁₆	6 ³ / ₈	2	1/4	4.795	5.047	5 NPT	5 NPSM	45°	5 ³⁷ / ₆₄	5 ¹¹ / ₁₆
6	3	7 ¹¹ / ₁₆	2	5/16	5.762	6.065	6 NPT	6 NPSM	45°	6 ⁴¹ / ₆₄	6 ³ / ₄

Bulkhead dimensions (in inches):

Cat. #	Size	A	B	H	M	N
STTB 1						
STTB 1	1/2	1.465	1.429	60°	1/2 - 14 NPSM	1/2 - 14 NPT
STTTB 1						
STTTBA 1						
STTB 2						
STTB 2	3/4	1.652	1.677	60°	3/4 - 14 NPSM	3/4 - 14 NPT
STTTB 2						
STTTBA 2						
STTB 3						
STTB 3	1	1.801	1.998	60°	1 - 11 1/2 NPSM	1 - 11 1/2 NPT
STTTB 3						
STTTBA 3						
STTB 4						
STTB 4	1 1/4	1.711	2.373	60°	1 1/4 - 11 1/2 NPSM	1 1/4 - 11 1/2 NPT
STTTB 4						
STTTBA 4						
STTB 5						
STTB 5	1 1/2	1.717	2.741	60°	1 1/2 - 11 1/2 NPSM	1 1/2 - 11 1/2 NPT
STTTB 5						
STTTBA 5						
STTB 6						
STTB 6	2	1.755	3.230	60°	2 - 11 1/2 NPSM	2 - 11 1/2 NPT
STTTB 6						
STTTBA 6						
STTB 7						
STTB 7	2 1/2	2.500	3.747	45°	2 1/2 - 8 NPSM	2 1/2 - 8 NPT
STTB 8						
STTB 8	3	2.500	4.392	45°	3 - 8 NPSM	3 - 8 NPT
STTB 9						
STTB 9	3 1/2	2.290	4.975	45°	3 1/2 - 8 NPSM	3 1/2 - 8 NPT
STTB 10						
STTB 10	4	2.439	5.516	45°	4 - 8 NPSM	4 - 8 NPT

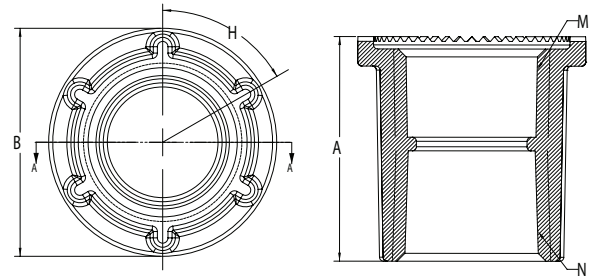

Spacing chart: Conduit or pipe size

Cond. size	1/4	3/8	1/2	3/4	1	1 1/4	1 1/2	2	2 1/2	3	3 1/2	4	5	6
3/8	1 5/32	1 1/4												
1/2	1 5/16	1 13/32	1 9/16											
3/4	1 7/16	1 17/32	1 11/16	1 13/16										
1	1 9/32	1 11/16	1 27/32	1 31/32	2 1/8									
1 1/4	1 25/32	1 7/8	2 1/32	2 5/32	2 5/16	2 1/2								
1 1/2	1 31/32	2 1/16	2 1/32	2 11/32	2 1/2	2 11/16	2 7/8							
2	2 1/32	2 5/16	2 15/32	2 19/32	2 3/4	2 15/16	3 1/8	3 3/8						
2 1/2	2 15/32	2 9/16	2 23/32	2 27/32	3	3 3/16	3 3/8	3 5/8	3 7/8					
3	2 25/32	2 7/8	3 1/32	3 5/32	3 5/16	3 1/2	3 11/16	3 15/16	4 3/16	4 1/2				
3 1/2	3 3/32	3 3/16	3 11/32	3 15/32	3 5/8	3 13/16	4	4 1/4	4 1/2	4 13/16	5 1/8			
4	3 11/32	3 7/16	3 19/32	3 23/32	3 7/8	4 1/16	4 1/4	4 1/2	4 3/4	5 1/16	5 5/8	5 3/4		
5	4 1/32	4 3/8	4 9/32	4 13/32	4 9/16	4 3/4	4 15/16	5 3/16	5 1/16	5 5/4	6 1/16	6 3/16	7 1/8	
6	4 13/32	4 1/2	4 21/32	4 25/32	4 15/16	5 1/8	5 5/16	5 9/16	5 13/16	6 1/8	6 1/16	6 11/16	7 3/8	7 3/4

Minimum space from center of pipe or conduit to nearest obstruction.

1. Dimensions in top row (boxed squares) are centers for conduits of same size.

Example: How close may 3" conduits be spaced? Answer 4 1/2".

2. Dimensions in gray shaded squares are for centers of conduits **NQT** of the same size.

Example: What is the minimum spacing for 2" and 3/4" conduit?

Read down column marked 3/4" to figure opposite 2" and find dimension is 2 9/32".

Note: Minimum spacing dimensions as shown will give approximately 1/16" clearance between locking nuts.

Conduit hubs

Minimum space from center of pipe or conduit to nearest obstruction

	19/32	11/16	27/32	31/32	1 1/8	1 5/16	1 1/2	1 3/4	2	2 5/16	2 5/8	2 7/8	3 9/16	3 15/16
--	-------	-------	-------	-------	-------	--------	-------	-------	---	--------	-------	-------	--------	---------