

# Ark-Gard ENP plugs for ENR receptacles and ENC connectors

Cl. I, Div. 1 & 2, Groups B, C, D  
Cl. II, Div. 1 & 2, Groups F, G  
Cl. III  
NEMA 3, 7BCD, 9FG, 12

Explosionproof  
Dust-ignitionproof  
Raintight  
Wet Locations

2P

## Applications:

Ark-Gard® ENP plugs are used:

- With portable electrical equipment, such as compressors, tools, lighting systems and similar devices
- In areas made hazardous by the presence of flammable vapors and gases or combustible dusts
- Wherever portable electrical equipment is likely to be transferred from hazardous to non-hazardous areas
- In damp and corrosive areas
- When power requirements do not exceed 20 amperes
- Where general purpose application is required

## Features:

- Captive set screw design is now standard on all ENP plugs
- Design assures ease of installation and reduces likelihood of losing critical components in the field
- Insulator and contact components are now a single piece assembly
- ENP plugs can be used in non-hazardous areas with standard U-ground NEMA/EEMAC configuration 5 and 6 receptacles, eliminating the need for two separately equipped portable units of the same type; the ENR receptacle will not accept standard NEMA/EEMAC configuration plugs
- ENP plug handle body is designed with an internal cord strain relief mechanism and a cable sealing grommet which will accept various cable diameters
- Field assembly is accomplished with standard tools
- Ark-Gard 2 receptacle incorporates three spring-loaded slide keys that prevent the receptacle face plate from being rotated until the ENP plug is fully inserted into the receptacle. To make the connection, the ENP plug is fully inserted, and the receptacle face moved inward by pushing the plug forward. The plug is then rotated, closing the circuit. As rotation begins, the plug becomes locked in the receptacle and cannot be accidentally disengaged. In making or breaking the circuit, any resulting electrical arc is confined in the factory sealed chamber.

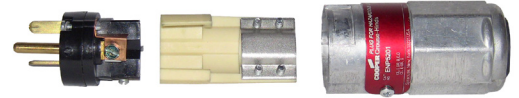

## Certifications and compliances:

### NEC:

- Class I, Divisions 1 & 2, Groups B, C, D
- Class II, Divisions 1 & 2, Groups F, G
- Class III

### ANSI/UL standard:

- UL1010

### NEMA/EEMAC:

- NEMA/EEMAC 3, 7BCD, 9FG





### CEC:

- Class I, Divisions 1 & 2, Groups B, C, D
- Class II, Divisions 1 & 2, Group G
- Class III

## Standard materials:

- Plug body – die cast copper-free aluminum
- Interior – nylon 100
- Contacts – brass
- Plug bushing – neoprene

## Ordering information:

Rating	NEMA configuration	Cat. #
15A, 125V		ENP5151
15A, 250V		ENP6152
20A, 125V		ENP5201
20A, 250V		ENP6202

## Standard finishes:

- Copper-free aluminum – aluminum acrylic paint
- Brass – natural

## Electrical ratings:

- Plugs – 15 and 20 amperes; 125 VAC and 250 VAC, 50-400 Hz

## Grounding:

- NEC Article 501 and CEC Section 18 require that metal frames or exposed non-current-carrying metal parts of portable devices used in hazardous locations be grounded through an extra conductor in the portable cord
- ENR receptacles and ENP plugs are provided with an extra grounding pole

**CAUTION:** To reduce the risk of ignition of hazardous atmospheres, do not use plugs or receptacles in Class II, Group F locations that contain electrically conductive dusts.

## Dimensions (in inches):

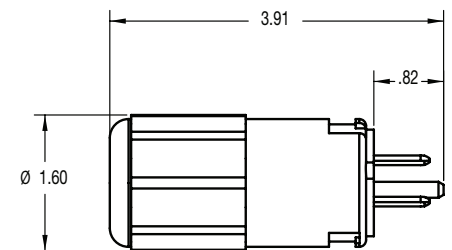

## Premier and value series

### Ark-Gard premier series:

- The premier line of ENR receptacles (M4) come equipped with exclusive features that increase the life of the product, reduce maintenance costs and eliminate the need to purchase costly replacement parts. There is no other product offering on the market today that comes equipped with time saving saddle clamp terminals or the added safety of a lockout/tagout hole. The premier ENR receptacle series is the ideal solution for applications where increased safety and reliability are critical.

### Ark-Gard value series:

- The value line of ENR receptacles is the ideal solution for rugged and industrial NEMA configured applications up to 20 amperes. Like the premier line, this product comes equipped with built-in safety features that reject standard NEMA configuration plugs that could cause an arc in hazardous areas.

### FEATURES AND BENEFITS - premier solution (M4)

#### Gasketed screw cap cover design:

- Offers superior protection from harsh environments for increased product life
- Eliminates the need to purchase a separate environmental cover for added protection

#### Complies with OSHA lockout/tagout requirements:

- Lockout/tagout hole in cover gives users the ability to lock the cover closed while not in use

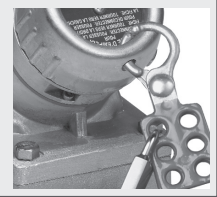

#### Spring-loaded sliding key offers increased safety:

- Rejects standard NEMA/EEMAC configuration plugs that could cause an arc in a hazardous area
- Also prevents the receptacle face plate from being rotated until the ENP plug is fully inserted

#### Protected hinge:

- Cap design provides 360° of protection around cover hinge to reduce damage from dirt and corrosion

#### Saddle clamp terminals:

- Reduce installation and maintenance costs – easy to wire, time saving terminals

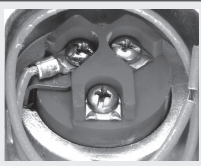

#### Integral bushings:

- Taper tapped hubs protect wire installation during wire pulling

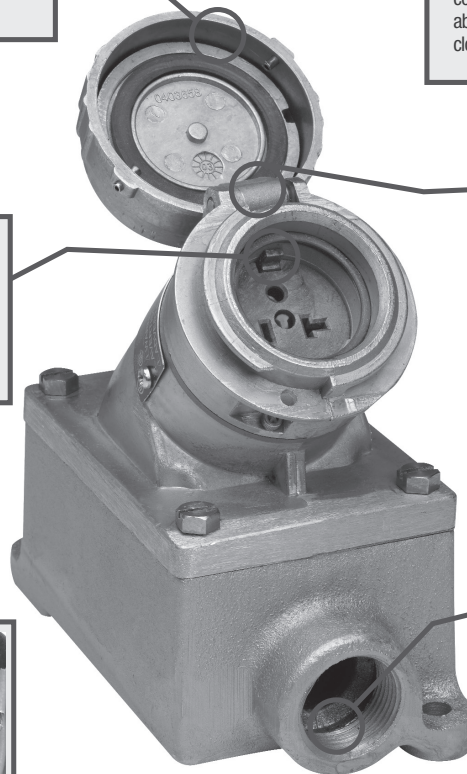

### FEATURES AND BENEFITS - traditional value solution

- To make connection, simply insert the ENP plug and rotate to close the circuit
- Built-in features cause the ENP plug to become locked in the receptacle and cannot be accidentally disengaged while in use

- Top hinged cover design with 45° downward angle provides protection in damp, wet and dirty locations

- Molded-in contact design provides for superior interior contact reliability
- Incorporates three spring-loaded slide keys that prevent the receptacle face plate from being rotated until the ENP plug is fully inserted into the receptacle

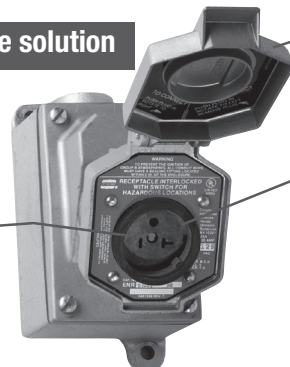

# Ark-Gard ENR premier series dead front interlocked circuit breaking receptacles

Cl. I, Div. 1 & 2, Groups B<sup>A</sup>, C, D  
Cl. II, Div. 1 & 2, Groups F, G  
Cl. III  
NEMA 3, 3R, 7BCD, 9FG, 12

Explosionproof  
Dust-ignitionproof  
Raintight  
Wet Locations

2P

## Applications:

Ark-Gard products are used:

- In applications that require additional environmental protection
- With portable or fixed electrical equipment, such as motor generator units, welders, pumps, compressors, heating and cooling units, cellular relay stations, conveyors, lighting systems and similar equipment
- In areas made hazardous by the presence of flammable vapors and gases or combustible dusts
- When power requirements do not exceed 20 amperes

## Certifications and compliances:

### NEC:

- Class I, Division 1, Groups B<sup>A</sup>, C, D
- Class II, Groups F, G
- Class III
- NEMA 3, 3R

### CEC<sup>®</sup>:

- Class I, Division 1, Groups B<sup>A</sup>, C, D
- Class II, Group G and Coal Dust
- Class III
- NEMA 3, 3R

## Standard materials:

- Receptacle housing, spring door and plug body – die cast copper-free aluminum
- Interiors – receptacle: Krydon fiberglass-reinforced polyester; plug: nylon 100
- Contacts – receptacle blade: brass; receptacle switch: silver; plug: brass
- Receptacle cover hinge pin and spring – stainless steel
- Receptacle gasket – neoprene
- Plug bushing – neoprene
- Back boxes – copper-free aluminum

## Standard finishes:

- Copper-free aluminum – aluminum acrylic paint
- Brass – natural

## Options:

### Description

- Corro-free epoxy powder finish for added corrosion resistance ..... **S752**

Suffix

## Electrical ratings:

- 15 and 20 amperes; 125 VAC and 250 VAC, 50-400 Hz

## Grounding:

- NEC Article 501 and CEC Section 18 requires that metal frames or exposed non-current-carrying metal parts of portable devices used in hazardous locations be grounded through an extra conductor in the portable cord
- ENR receptacles and ENP plugs are provided with an extra grounding pole

## Dimensions (in inches):

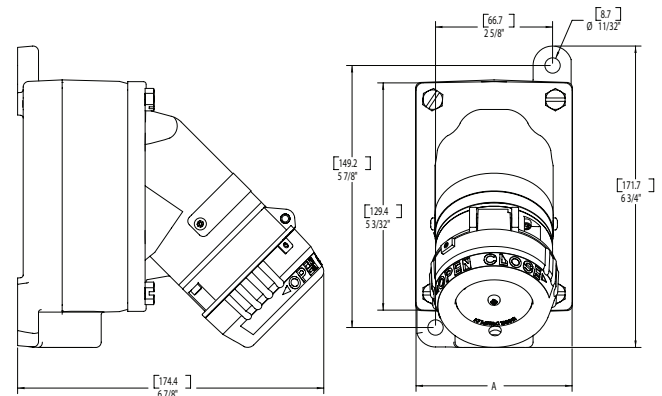

Type	Dimension A
Single-gang	3 1/2
Two-gang	7 9/16

<sup>A</sup> Single-gang assemblies purchased with an EFS back box are suitable for Class I, Group B. For Class I, Group B applications in Canada, please contact Customer Service.

<sup>B</sup> 15A units are CSA listed only.

# Ark-Gard ENR premier series dead front interlocked circuit breaking receptacles

Cl. I, Div. 1 & 2, Groups B, C, D  
Cl. II, Div. 1 & 2, Groups F, G  
Cl. III  
NEMA 3, 3R, 7BCD, 9FG, 12

Explosionproof  
Dust-ignitionproof  
Raintight  
Wet Locations

2P

## Ordering information:



Rating	Description	Hub size	Cat. # Single-gang receptacle assembly <sup>C</sup>	Cat. # Two-gang receptacle assembly <sup>D</sup>	Cat. # Group B listed single-gang assembly <sup>E</sup>	Cat. # Receptacle unit only <sup>F</sup>	NEMA config.	Cat. # 15A plug <sup>G</sup>	NEMA config.
15A, 125V	Dead end	1/2"	ENR11151 M4	ENR12151 M4	ENRB11151 M4	ENR5151 M4		ENP5151	
		3/4"	ENR21151 M4	ENR22151 M4	ENRB21151 M4				
		1"	ENR31151 M4	ENR32151 M4	ENRB31151 M4				
	Through feed	1/2"	ENRC11151 M4	ENRC12151 M4	ENRCB11151 M4				
		3/4"	ENRC21151 M4	ENRC22151 M4	ENRCB21151 M4				
		1"	ENRC31151 M4	ENRC32151 M4	ENRCB31151 M4				
15A, 250V	Dead end	1/2"	ENR11152 M4	ENR12152 M4	ENRB11152 M4	ENR6152 M4		ENP6152	
		3/4"	ENR21152 M4	ENR22152 M4	ENRB21152 M4				
		1"	ENR31152 M4	ENR32152 M4	ENRB31152 M4				
	Through feed	1/2"	ENRC11152 M4	ENRC12152 M4	ENRCB11152 M4				
		3/4"	ENRC21152 M4	ENRC22152 M4	ENRCB21152 M4				
		1"	ENRC31152 M4	ENRC32152 M4	ENRCB31152 M4				

Rating	Description	Hub size	Cat. # Single-gang receptacle assembly <sup>C</sup>	Cat. # Two-gang receptacle assembly <sup>D</sup>	Cat. # Group B listed single-gang assembly <sup>E</sup>	Cat. # Receptacle unit only <sup>F</sup>	NEMA config.	Cat. # 20A plug <sup>G</sup>	NEMA config.
20A, 125V	Dead end	1/2"	ENR11201 M4	ENR12201 M4	ENRB11201 M4	ENR5201 M4		ENP5201	
		3/4"	ENR21201 M4	ENR22201 M4	ENRB21201 M4				
		1"	ENR31201 M4	ENR32201 M4	ENRB31201 M4				
	Through feed	1/2"	ENRC11201 M4	ENRC12201 M4	ENRCB11201 M4				
		3/4"	ENRC21201 M4	ENRC22201 M4	ENRCB21201 M4				
		1"	ENRC31201 M4	ENRC32201 M4	ENRCB31201 M4				
20A, 250V	Dead end	1/2"	ENR11202 M4	ENR12202 M4	ENRB11202 M4	ENR6202 M4		ENP6202	
		3/4"	ENR21202 M4	ENR22202 M4	ENRB21202 M4				
		1"	ENR31202 M4	ENR32202 M4	ENRB31202 M4				
	Through feed	1/2"	ENRC11202 M4	ENRC12202 M4	ENRCB11202 M4				
		3/4"	ENRC21202 M4	ENRC22202 M4	ENRCB21202 M4				
		1"	ENRC31202 M4	ENRC32202 M4	ENRCB31202 M4				

Note: Assemblies standard with copper-free aluminum EDS, EDSC, EFS, EFSC back boxes.

<sup>C</sup>Single-gang assemblies purchased with an EDS back box are suitable for Class I, Groups C, D only. For self-certified Class I, Group B rating, add suffix 'GB' to end of catalog number (i.e. ENR21201 M4 GB). For Class I, Group B applications in Canada, please contact Customer Service.

<sup>D</sup>Two-gang assemblies purchased with an EDS back box are suitable for Class I, Groups C, D only. For self-certified Class I, Group B rating, add suffix 'GB' to end of catalog number (i.e. ENR22201 M4 GB). For Class I, Group B applications in Canada, please contact Customer Service.

<sup>E</sup>Single-gang assemblies purchased with an EFS back box are suitable for Class I, Group B.

<sup>F</sup>Receptacle units alone (i.e. ENR5201) are not suitable for Class I, Group B.

<sup>G</sup>ENP plugs use #12 or #14 AWG type S, SO, ST or STO cord with range of 0.540 - 0.635" diameter.

# Ark-Gard ENR value series dead front interlocked circuit breaking receptacles

Cl. I, Div. 1 & 2, Groups B<sup>A</sup>, C, D  
Cl. II, Div. 1 & 2, Groups F, G  
Cl. III  
NEMA 3, 7BCD, 9FG, 12

Explosionproof  
Dust-ignitionproof  
Raintight  
Wet Locations

2P

## Applications:

Ark-Gard ENR receptacles and ENP plugs are used:

- With portable electrical equipment, such as compressors, tools, lighting systems and similar devices
- In areas made hazardous by the presence of flammable vapors and gases or combustible dusts
- Wherever portable electrical equipment is likely to be transferred from hazardous to non-hazardous areas
- In damp and corrosive areas
- When power requirements do not exceed 20 amperes
- Where general purpose application is required

## Features:

- Ark-Gard 2 receptacle incorporates three spring-loaded slide keys that prevent the receptacle face plate from being rotated until the ENP plug is fully inserted into the receptacle. To make the connection, the ENP plug is fully inserted, and the receptacle face moved inward by pushing the plug forward. The plug is then rotated, closing the circuit. As rotation begins, the plug becomes locked in the receptacle and cannot be accidentally disengaged. In making or breaking the circuit, any resulting electrical arc is confined in the factory sealed chamber.
- Factory sealed chamber encloses the potential arcing components between two explosionproof threaded joints; these threads are specially coated to guarantee freedom of movement, which ensures on-off action; no additional seals are required
- One-piece molded gasket seals cover plate and ENP plug when plug is inserted, providing full environmental protection at the receptacle face
- Top hinged cover design with 45° downward angle provides superior protection in damp, wet and dirty locations
- Field assembly is accomplished with standard tools
- Use standard EDS back boxes

## Certifications and compliances:

### NEC:

- Class I, Divisions 1 & 2, Groups B<sup>A</sup>, C, D
- Class II, Divisions 1 & 2, Groups F, G
- Class III

### ANSI/UL standard:

- UL1010

### NEMA/EEMAC:

- NEMA/EEMAC 3, 7BCD, 9FG

### CEC:

- Class I, Divisions 1 & 2, Groups B, C, D
- Class II, Divisions 1 & 2, Group G
- Class III

## Standard materials:

- Receptacle housing and spring door – die cast copper-free aluminum
- Interior – Krydon fiberglass-reinforced polyester
- Contacts – receptacle blade: brass; receptacle switch: silver
- Receptacle cover hinge pin and spring – stainless steel
- Receptacle gasket – neoprene

## Standard finishes:

- Copper-free aluminum – aluminum acrylic paint
- Brass – natural

## Electrical ratings:

- 15 and 20 amperes; 125 VAC and 250 VAC, 50-400 Hz

## Grounding:

- NEC Article 501 and CEC Section 18 require that metal frames or exposed non-current-carrying metal parts of portable devices used in hazardous locations be grounded through an extra conductor in the portable cord
- ENR receptacles and ENP plugs are provided with an extra grounding pole

**CAUTION:** To reduce the risk of ignition of hazardous atmospheres, do not use plugs or receptacles in Class II, Group F locations that contain electrically conductive dusts.

## Dimensions (in inches):

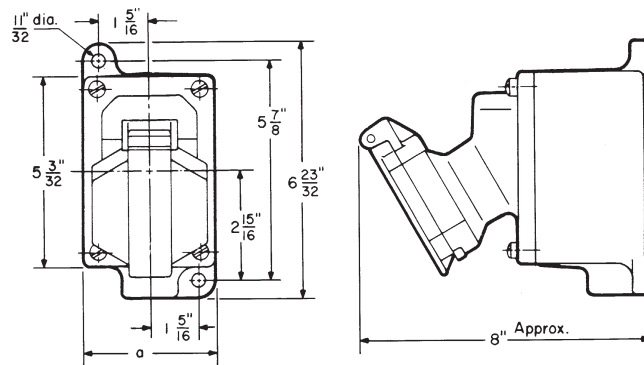

a = 3 1/2 for single-gang  
7 9/16 for two-gang

<sup>A</sup> Receptacle units alone (i.e. ENR5201) are not suitable for Class I, Group B.

# Ark-Gard ENR value series dead front interlocked circuit breaking receptacles

Cl. I, Div. 1 & 2, Groups B, C, D  
Cl. II, Div. 1 & 2, Groups F, G  
Cl. III  
NEMA 3, 7BCD, 9FG, 12

Explosionproof  
Dust-ignitionproof  
Raintight  
Wet Locations

2P

## Ordering information:

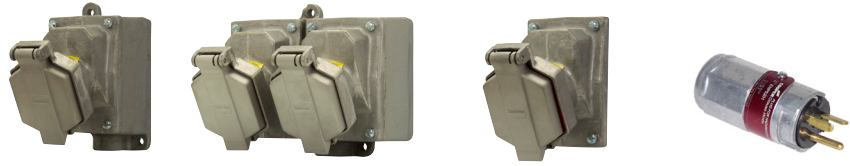

Rating	Description	Hub size	Cat. # Single-gang receptacle assembly <sup>Ⓒ</sup>	Cat. # Two-gang receptacle assembly <sup>Ⓓ</sup>	Cat. # Receptacle unit only <sup>Ⓔ</sup>	NEMA config.	Cat. # 15A plug <sup>Ⓔ</sup>	NEMA config.
15A, 125V	Dead end	1/2"	ENR11151	ENR12151	ENR5151		ENP5151	
		3/4"	ENR21151	ENR22151				
		1"	ENR31151	ENR32151				
	Through feed	1/2"	ENRC11151	ENRC12151				
		3/4"	ENRC21151	ENRC22151				
		1"	ENRC31151	ENRC32151				
15A, 250V	Dead end	1/2"	ENR11152	ENR12152	ENR6152		ENP6152	
		3/4"	ENR21152	ENR22152				
		1"	ENR31152	ENR32152				
	Through feed	1/2"	ENRC11152	ENRC12152				
		3/4"	ENRC21152	ENRC22152				
		1"	ENRC31152	ENRC32152				

Rating	Description	Hub size	Cat. # Single-gang receptacle assembly <sup>Ⓒ</sup>	Cat. # Two-gang receptacle assembly <sup>Ⓓ</sup>	Cat. # Receptacle unit only <sup>Ⓔ</sup>	NEMA config.	Cat. # 20A plug <sup>Ⓔ</sup>	NEMA config.
20A, 125V	Dead end	1/2"	ENR11201	ENR12201	ENR5201		ENP5201	
		3/4"	ENR21201	ENR22201				
		1"	ENR31201	ENR32201				
	Through feed	1/2"	ENRC11201	ENRC12201				
		3/4"	ENRC21201	ENRC22201				
		1"	ENRC31201	ENRC32201				
20A, 250V	Dead end	1/2"	ENR11202	ENR12202	ENR6202		ENP6202	
		3/4"	ENR21202	ENR22202				
		1"	ENR31202	ENR32202				
	Through feed	1/2"	ENRC11202	ENRC12202				
		3/4"	ENRC21202	ENRC22202				
		1"	ENRC31202	ENRC32202				

Note: 15A with copper-free aluminum EDS, EDSC Back Boxes. 20A with Feraloy® iron alloy EDS, EDSC Back Boxes.

<sup>Ⓔ</sup> Receptacle units alone (i.e. ENR5201) are not suitable for Class I, Group B.

<sup>Ⓒ</sup> Single-gang assemblies purchased with an EDS back box are suitable for Class I, Group B.

<sup>Ⓓ</sup> Two-gang assemblies purchased with an EDS back box are suitable for Class I, Groups C, D only. For Class I, Group B rating, add 'B' to catalog number. For example: ENRB22201. Seals must be installed within 1/2" of each conduit opening.

<sup>Ⓔ</sup> ENP plugs use #12 or #14 AWG type S, SO, ST or STO cord with range of 0.540 - 0.635" diameter.

## Applications:

Ark-Gard ENC connectors:

- Make it safe and easy to bring power wherever it is needed
- Provide versatility for making cordsets for connecting portable devices in both hazardous and non-hazardous locations

Hazardous ENC connectors are used:

Standard maintenance or plant turnarounds to provide power connections for:

- Portable hand lamps for visual inspections
- Portable light fixtures for general illumination
- Portable hand tools such as saws or grinders

Standard operation to provide a means of quick disconnect to move or disassemble equipment, such as:

- Motor generator units
- Portable control rooms
- Pumps and motors

Common applications include:

- Refineries
- Chemical plants
- LNG facilities
- Wastewater treatment facilities
- Drilling and exploration

## Certifications and compliances:

- Class I, Groups B, C, D
- Class II, Group G, Coal Dust
- Class III
- NEMA 3R, Weatherproof
- NEC Article 501.140 compliance
- CSA C22.2 No. 159M

## Standard materials:

- Connector bodies – high impact strength copper-free aluminum
- Insulation – fiberglass-reinforced polyester
- Contacts – receptacle blade: brass; receptacle switch: silver; plug: brass

## Standard finishes:

- Aluminum – natural
- Fiberglass-reinforced polyester – red

## Options:

### Description

- Corro-free epoxy powder finish for added corrosion resistance .....









### Suffix

**S752**

## Electrical ratings:

- 15 and 20 amperes, 125 and 250 VAC

## Ordering information:

Rating	Cord range	Cat. # Connector	NEMA configuration	Cat. # Plug	NEMA configuration
15A, 125V	0.39 - 1.20"	ENC5151 CAN	 5-15R	ENP5151	 5-15P
15A, 250V	0.39 - 1.20"	ENC6152 CAN	 6-15R	ENP6152	 6-15P
20A, 125V	0.39 - 1.20"	ENC5201 CAN	 5-20R	ENP5201	 5-20P
20A, 250V	0.39 - 1.20"	ENC6202 CAN	 6-20R	ENP6202	 6-20P

## Dimensions (in inches):

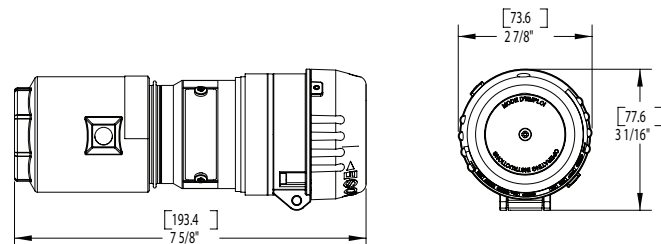

## FEATURES AND BENEFITS

### Uni-Shell handle body:

- Provides a smooth, durable external surface that prevents the connector from getting snagged on equipment or other cables

### Spring-loaded sliding key offers increased safety:

- Rejects standard NEMA/EEMAC configuration plugs that could cause an arc in a hazardous area
- Prevents the face plate from being rotated until the ENP plug is fully inserted

### Increased environmental reliability with hinged locking cover:

- Provides weather protection in damp, wet and dirty locations
- Cover stays closed until connection with ENP plug is required

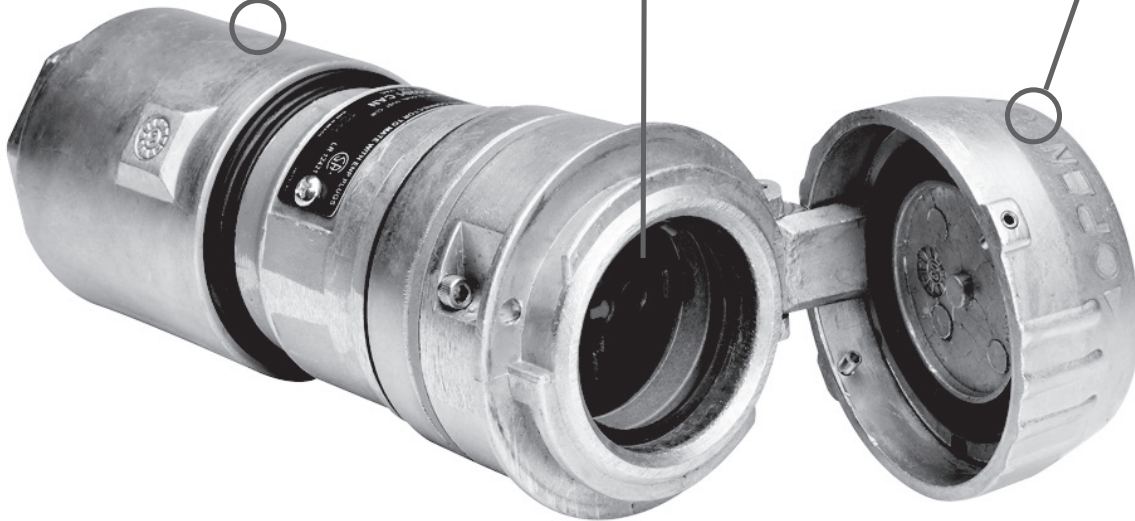

### Plug gaskets:

- Two gaskets cover the entire range of cable diameters, reducing risk of improper assembly
- Gasket ratchets into Tri-Lock cable grip to prevent connector from turning or loosening



### Improved safety with integral lockout/tagout:

- Eliminates risk of operator or contractor plugging in process equipment when conditions are unsafe



### Increased safety with captive Tri-Lock design:

- Three points of contact prevent pinching of cables that could damage internal conductors or cable jacket
- Captive screws prevent critical components from getting lost during installation

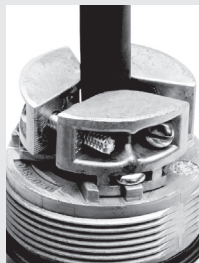

### Saddle clamp terminals:

- Increased safety with easy-to-terminate connection points for reliable conductor terminations

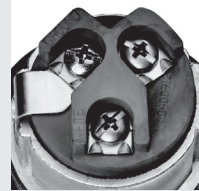

Mates with  
Eaton's Crouse-Hinds  
series frustration-free  
ENP plug



### Snap-in internal insulator:

- Increases safety of personnel with intermediate insulator between conductors and metallic outer shell

